

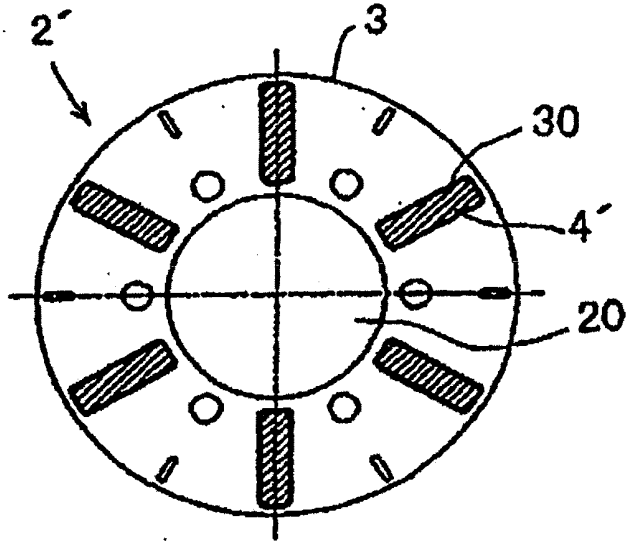

APPROVED BY EXAMINER  
HNN  
6/28/03

**Fig. 13 (A)**  
(Prior Art)



**Fig. 13 (B)**  
(Prior Art)

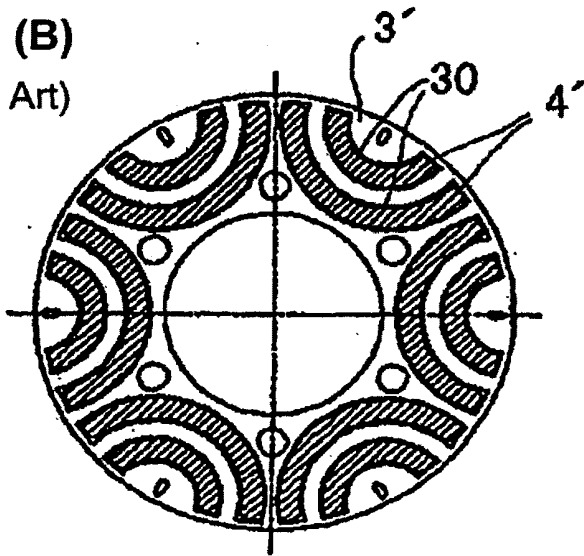



APPROVED BY EXAMINER  
HNN 6/26/03

**Fig. 14**  
(Prior Art)

